

RevNo	Revision note	Date	Reviser	Checked
-------	---------------	------	---------	---------

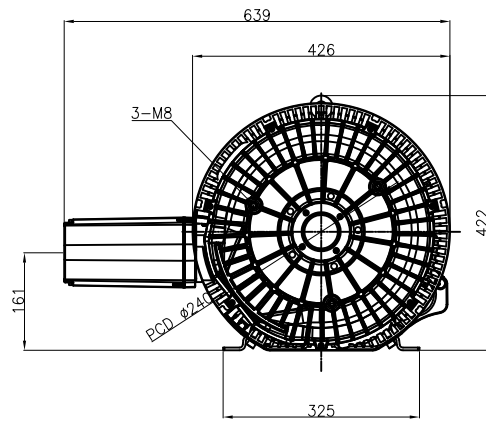

Left

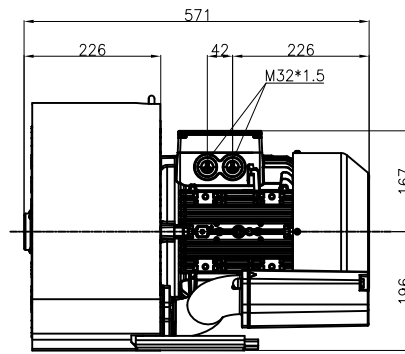

Front

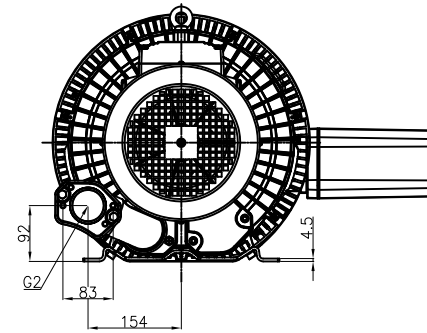

Right

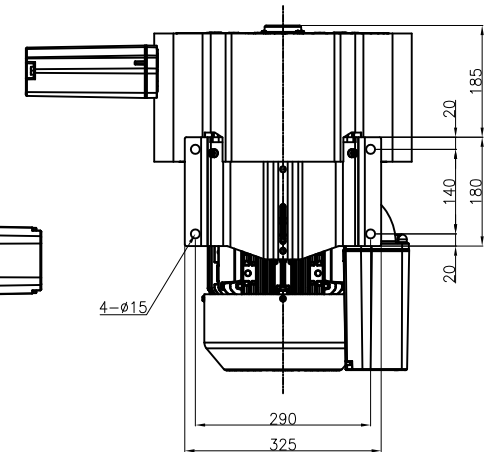

Bottom

No	Description	Specification	Q'ty	Material	Weight	Remark
Designed	Checked	Approved	Size	Filename	Date	Scale
			A3			1/1
Customer			Title Ring blower(HSEB-1002)			
Maker			3□ 220/380V, 50/60Hz, 8.6kw			
			drawing no.		Edition	
					0	