

1 2 3 4 5 6 7 8

RevNo	Revision note	Date	Reviser	Checked
-------	---------------	------	---------	---------

A

A

B

B

C

C

D

D

E

E

F

F

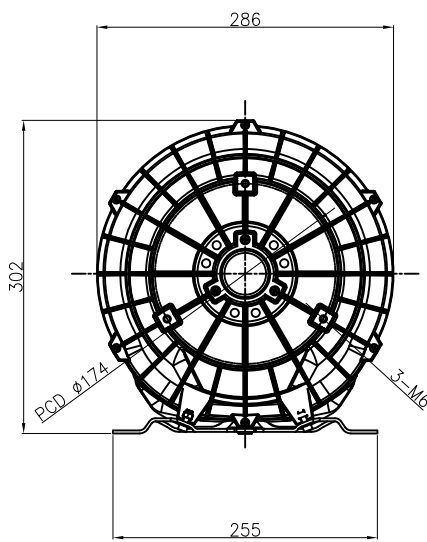

Left

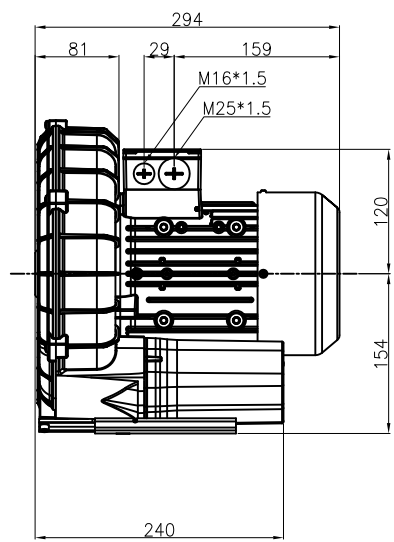

Front

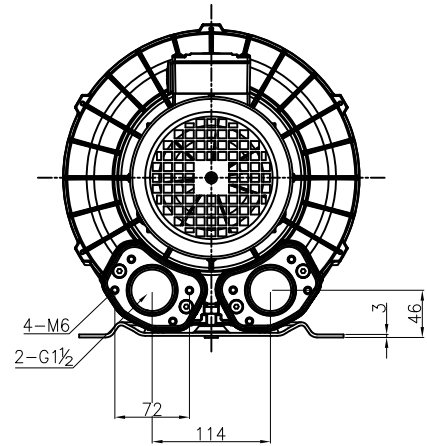

Right

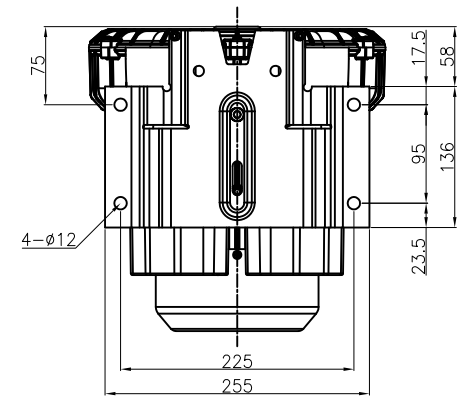

Bottom

No	Description	Specification	Q'ty	Material	Weight	Remark
Designed	Checked	Approved	Size	Filename	Date	Scale
			A3			1/1
Customer			Title			
			Ring blower(HSEB-201)			
Maker			1□ 220/240V, 50/60Hz, 0.95kw			
			drawing no.		Edition	
					0	

1 2 3 4 5 6 7 8